

General Description

The AON6404 combines advanced trench MOSFET technology with a low resistance package to provide extremely low $R_{DS(ON)}$. This device is ideal for load switch and battery protection applications.

Features

$$V_{DS} (V) = 30V$$

$$I_D = 85A (V_{GS} = 10V)$$

$$R_{DS(ON)} < 2.2m\Omega (V_{GS} = 10V)$$

$$R_{DS(ON)} < 3.8m\Omega (V_{GS} = 4.5V)$$

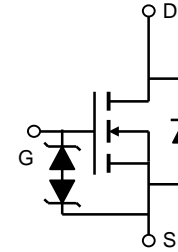
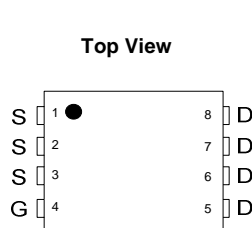

Absolute Maximum Ratings $T_A=25^\circ\text{C}$ unless otherwise noted

Parameter	Symbol	Maximum	Units
Drain-Source Voltage	V_{DS}	30	V
Gate-Source Voltage	V_{GS}	± 20	V
Continuous Drain Current ^{B,G}	$T_C=25^\circ\text{C}$	85	A
	$T_C=100^\circ\text{C}$	67	
Pulsed Drain Current	I_{DM}	160	
Continuous Drain Current ^A	$T_A=25^\circ\text{C}$	25	
	$T_A=70^\circ\text{C}$	20	
Avalanche Current	I_{AS}	85	
Single avalanche energy $L=0.1\text{mH}$	E_{AS}	361	mJ
Power Dissipation ^B	$T_C=25^\circ\text{C}$	83	W
	$T_C=100^\circ\text{C}$	33	
Power Dissipation ^A	$T_A=25^\circ\text{C}$	2.1	W
	$T_A=70^\circ\text{C}$	1.3	
Junction and Storage Temperature Range	T_J, T_{STG}	-55 to 150	$^\circ\text{C}$

Thermal Characteristics

Parameter	Symbol	Typ	Max	Units
Maximum Junction-to-Ambient ^A	$R_{\theta JA}$	15	20	$^\circ\text{C/W}$
Maximum Junction-to-Ambient ^A		Steady-State	45	60
Maximum Junction-to-Case ^C	$R_{\theta JC}$	1.1	1.5	$^\circ\text{C/W}$

Electrical Characteristics (T_J=25°C unless otherwise noted)

Symbol	Parameter	Conditions	Min	Typ	Max	Units
STATIC PARAMETERS						
B _V DSS	Drain-Source Breakdown Voltage	I _D =250μA, V _{GS} =0V	30	34		V
I _{DSS}	Zero Gate Voltage Drain Current	V _{DS} =30V, V _{GS} =0V T _J =55°C			1 5	μA
I _{GSS}	Gate-Body leakage current	V _{DS} =0V, V _{GS} = ±16V			10	μA
V _{GS(th)}	Gate Threshold Voltage	V _{DS} =V _{GS} I _D =250μA	1.4	1.7	2	V
I _{D(ON)}	On state drain current	V _{GS} =10V, V _{DS} =5V	160			A
R _{DS(ON)}	Static Drain-Source On-Resistance	V _{GS} =10V, I _D =20A T _J =125°C		1.8 2.5	2.2 3.1	mΩ
		V _{GS} =4.5V, I _D =20A		3	3.8	mΩ
g _{FS}	Forward Transconductance	V _{DS} =5V, I _D =20A		75		S
V _{SD}	Diode Forward Voltage	I _S =85A, V _{GS} =0V		0.87	1.3	V
I _S	Maximum Body-Diode Continuous Current				85	A
DYNAMIC PARAMETERS						
C _{iss}	Input Capacitance	V _{GS} =0V, V _{DS} =15V, f=1MHz		7420	9000	pF
C _{oss}	Output Capacitance			1045		pF
C _{rss}	Reverse Transfer Capacitance			720		pF
R _g	Gate resistance	V _{GS} =0V, V _{DS} =0V, f=1MHz		1.2	1.8	Ω
SWITCHING PARAMETERS						
Q _{g(10V)}	Total Gate Charge	V _{GS} =10V, V _{DS} =15V, I _D =20A		118	155	nC
Q _{g(4.5V)}	Total Gate Charge			54		nC
Q _{gs}	Gate Source Charge			29		nC
Q _{gd}	Gate Drain Charge			22		nC
t _{D(on)}	Turn-On DelayTime	V _{GS} =10V, V _{DS} =15V, R _L =0.75Ω, R _{GEN} =3Ω		17		ns
t _r	Turn-On Rise Time			18		ns
t _{D(off)}	Turn-Off DelayTime			67		ns
t _f	Turn-Off Fall Time			25		ns
t _{rr}	Body Diode Reverse Recovery Time	I _F =20A, di/dt=100A/μs		60	80	ns
Q _{rr}	Body Diode Reverse Recovery Charge	I _F =20A, di/dt=100A/μs		66		nC

A: The value of R_{θJA} is measured with the device in a still air environment with T_A=25°C, with the device mounted on 1 in2 FR-4 board with 2oz. Copper, in a still air environment with T_A=25°C

B: The power dissipation P_D is based on T_{J(MAX)}=150°C, using junction-to-case thermal resistance, and is more useful in setting the upper dissipation limit for cases where additional heatsink is used.

C: Repetitive rating, pulse width limited by junction temperature T_{J(MAX)}=150°C.

D: The R_{θJA} is the sum of the thermal impedance from junction to case R_{θJC} and case to ambient.

E: The static characteristics in Figures 1 to 6 are obtained using <300 μs pulses, duty cycle 0.5% max.

F: These curves are based on the junction-to-case thermal impedance which is measured with the device mounted to a large heatsink, assuming a maximum junction temperature of T_{J(MAX)}=150°C. The SOA curve provides a single pulse rating.

G: Maximum current is limited by the package.

Rev4: May 2011

THIS PRODUCT HAS BEEN DESIGNED AND QUALIFIED FOR THE CONSUMER MARKET. APPLICATIONS OR USES AS CRITICAL COMPONENTS IN LIFE SUPPORT DEVICES OR SYSTEMS ARE NOT AUTHORIZED. AOS DOES NOT ASSUME ANY LIABILITY ARISING OUT OF SUCH APPLICATIONS OR USES OF ITS PRODUCTS. AOS RESERVES THE RIGHT TO IMPROVE PRODUCT DESIGN, FUNCTIONS AND RELIABILITY WITHOUT NOTICE.

TYPICAL ELECTRICAL AND THERMAL CHARACTERISTICS

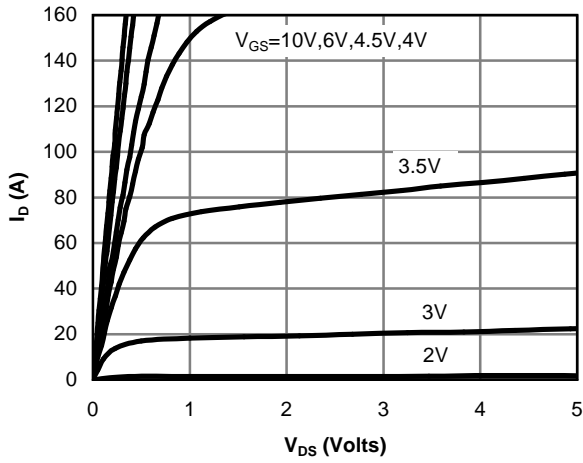

Fig 1: On-Region Characteristics

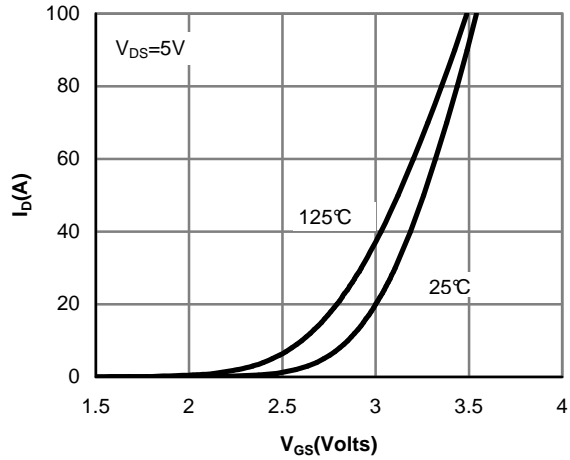

Figure 2: Transfer Characteristics

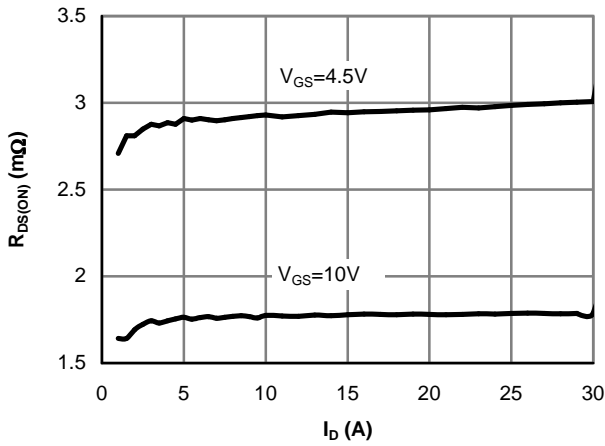

Figure 3: On-Resistance vs. Drain Current and Gate Voltage

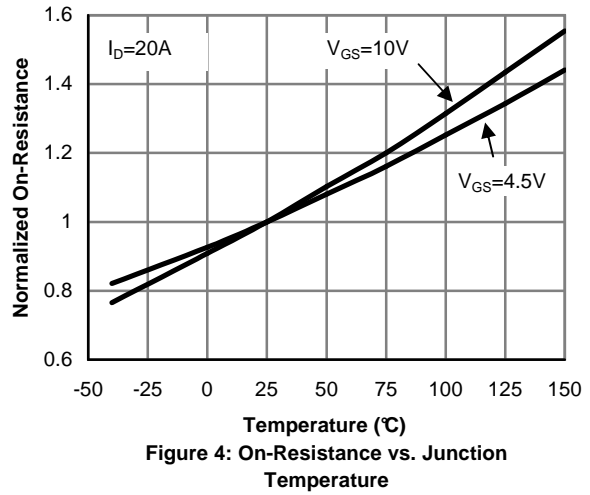

Figure 4: On-Resistance vs. Junction Temperature

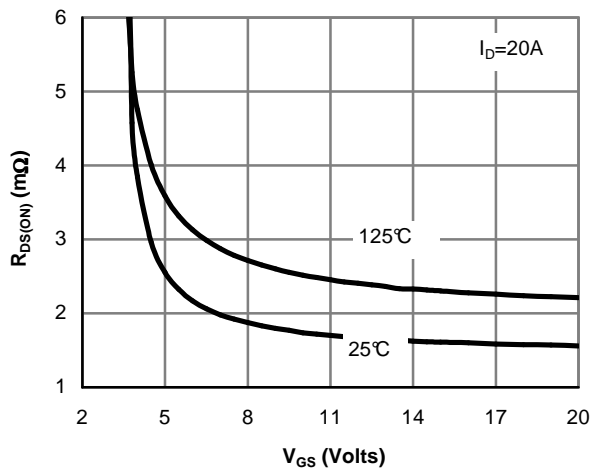

Figure 5: On-Resistance vs. Gate-Source Voltage

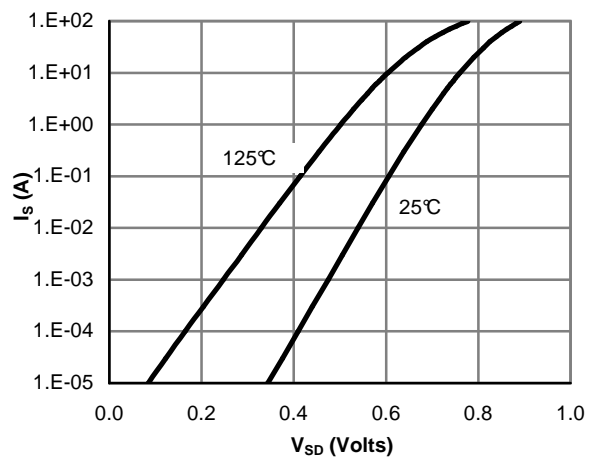

Figure 6: Body-Diode Characteristics

TYPICAL ELECTRICAL AND THERMAL CHARACTERISTICS

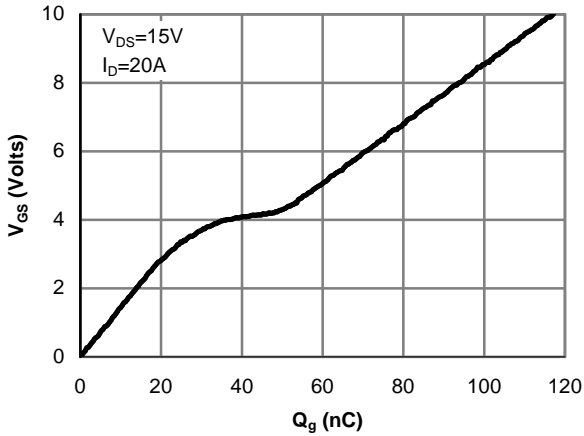

Figure 7: Gate-Charge Characteristics

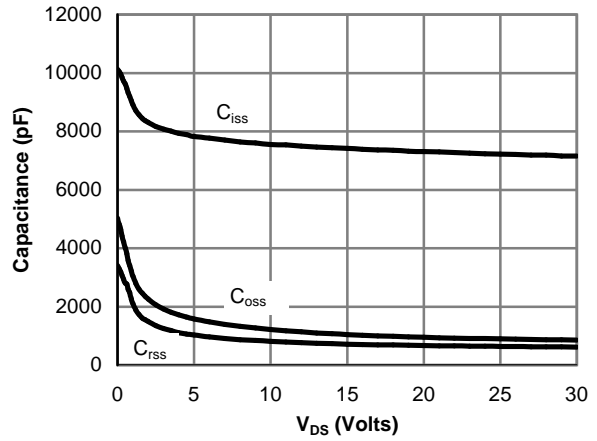

Figure 8: Capacitance Characteristics

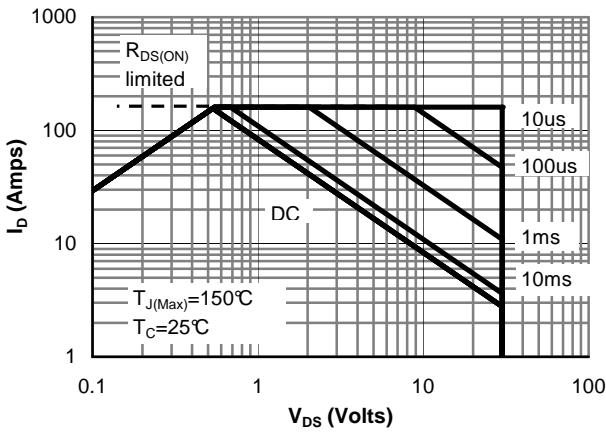

Figure 9: Maximum Forward Biased Safe Operating Area (Note F)

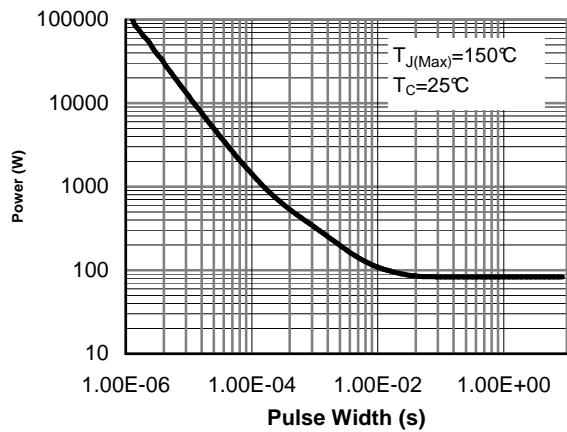

Figure 10: Single Pulse Power Rating Junction-to-Case (Note F)

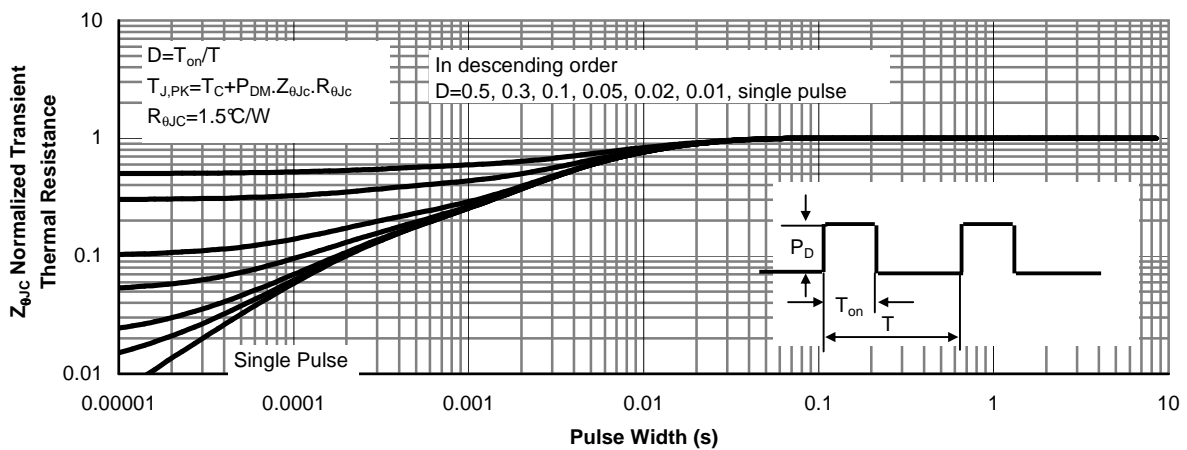

Figure 11: Normalized Maximum Transient Thermal Impedance (Note F)

TYPICAL ELECTRICAL AND THERMAL CHARACTERISTICS

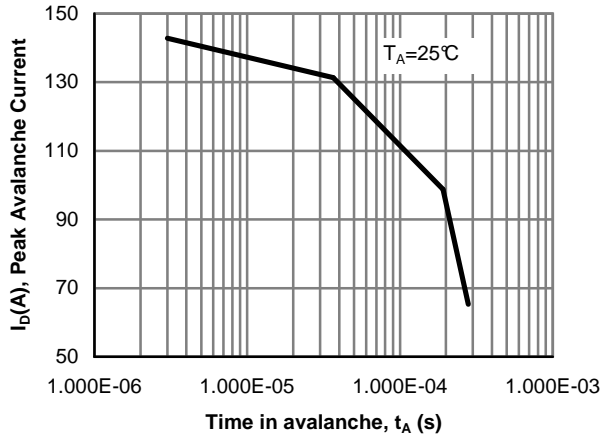

Figure 12: Single Pulse Avalanche capability

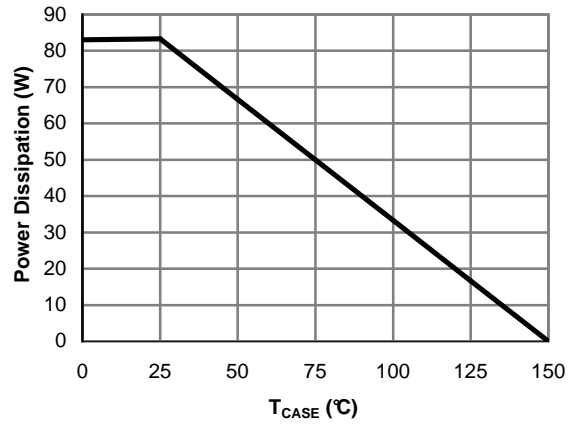

Figure 13: Power De-rating (Note B)

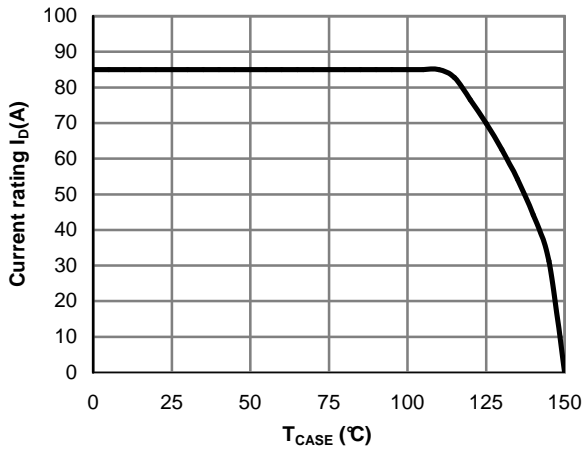

Figure 14: Current De-rating (Note B,G)

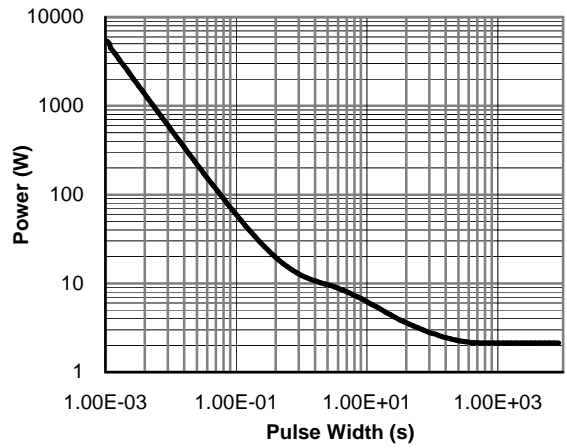

Figure 15: Single Pulse Power Rating Junction-to-Ambient (Note A)

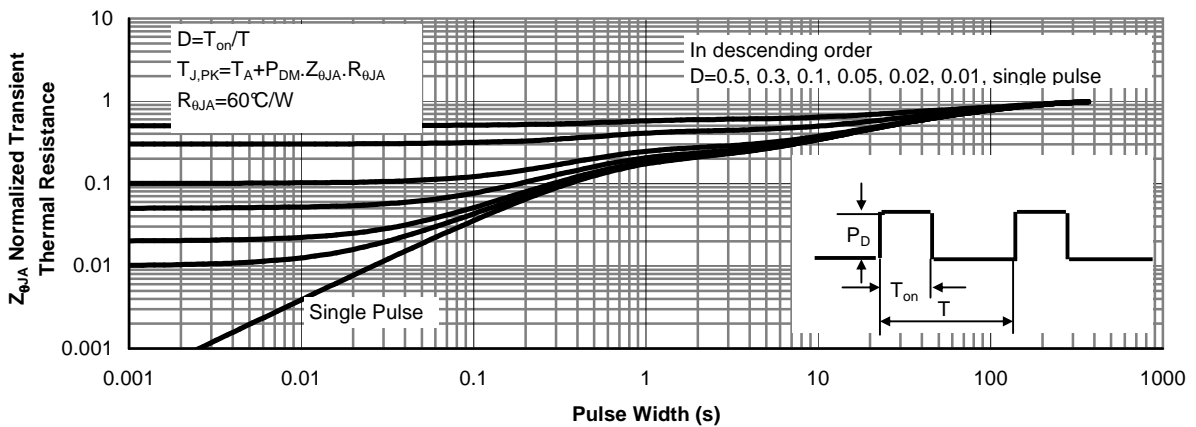
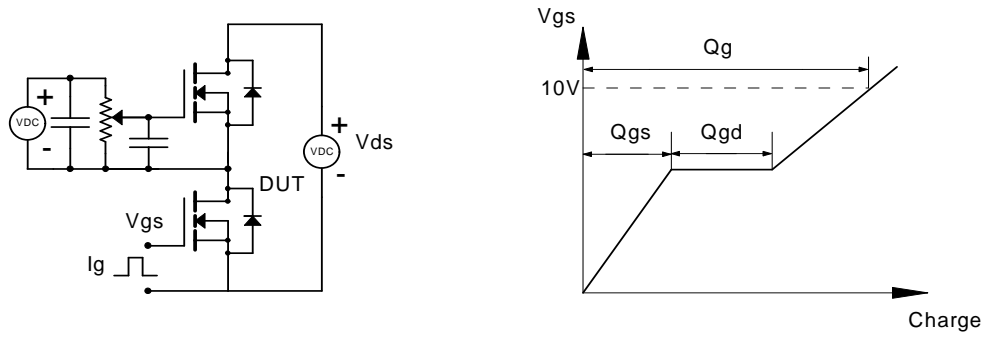
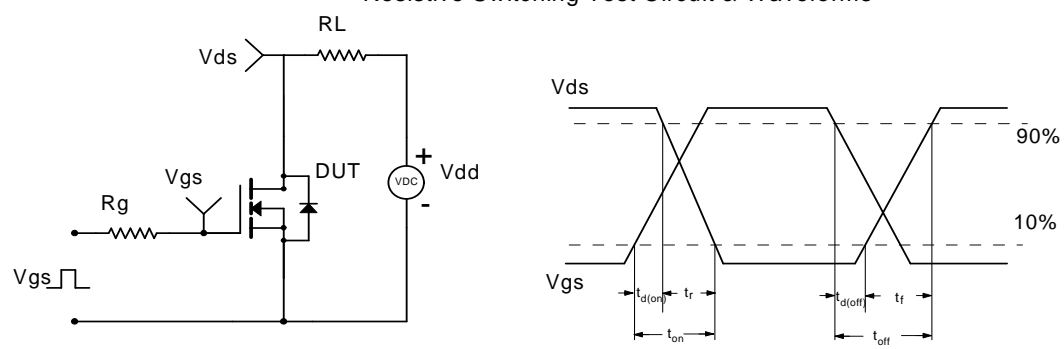

Figure 16: Normalized Maximum Transient Thermal Impedance (Note A)

Gate Charge Test Circuit & Waveform



Resistive Switching Test Circuit & Waveforms



Unclamped Inductive Switching (UIS) Test Circuit & Waveforms

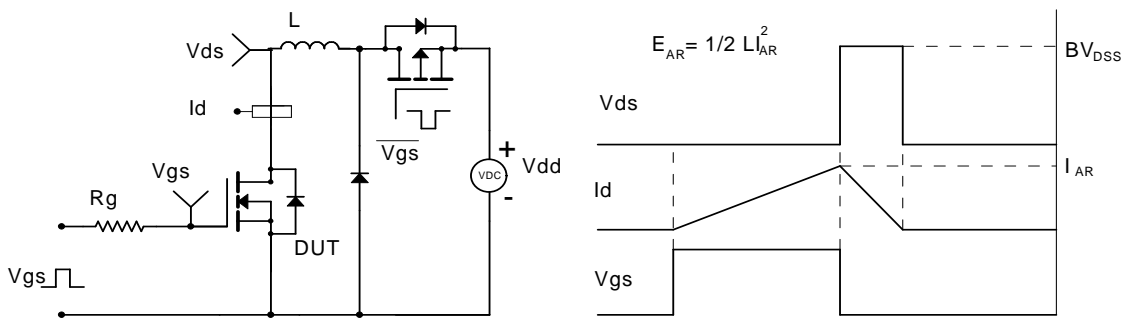

Diode Recovery Test Circuit & Waveforms

